

All dimensions in mm unless otherwise stated.

HALF ROUND 113MM PROFILE AND BRACKET

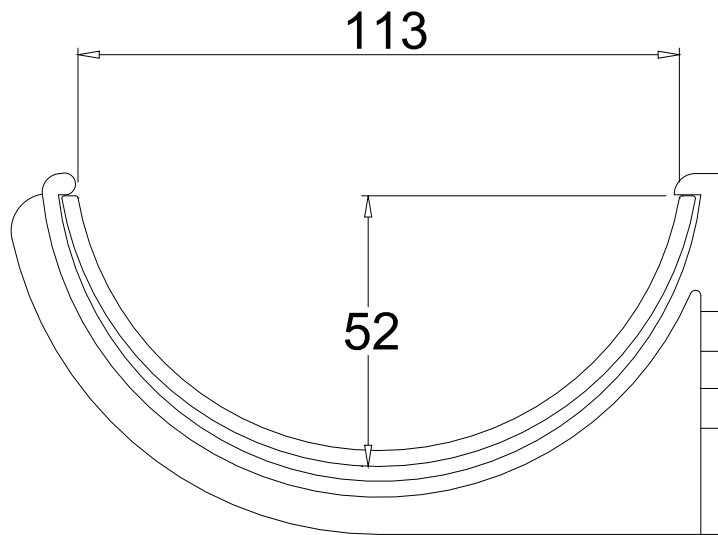

For illustrational purposes only

ALUTEC
ALUMINIUM RAINWATER SYSTEMS
MARLEY ALUTEC LTD
Unit 1 (G-H) Viking Industrial Park,
Hudson Road, Elms Farm Industrial Estate,
Bedford MK41 0LZ
Tel: 01234 359438 Fax: 01234 357199